

IRENA

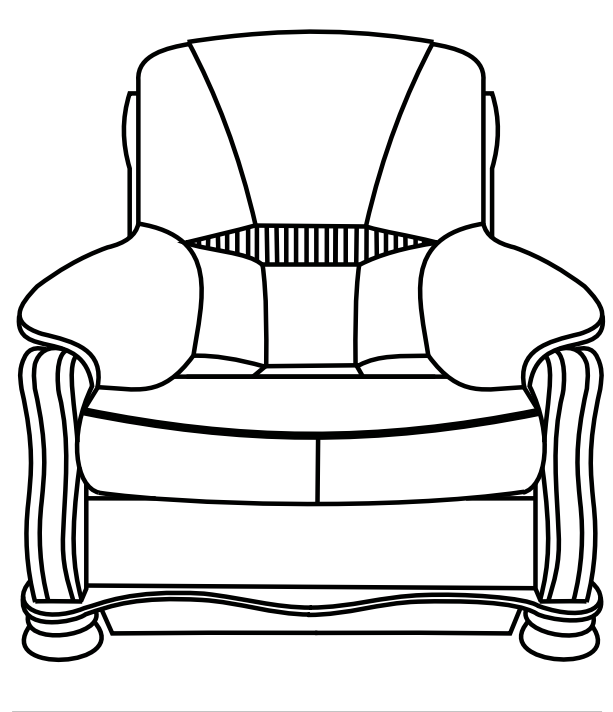

87 cm

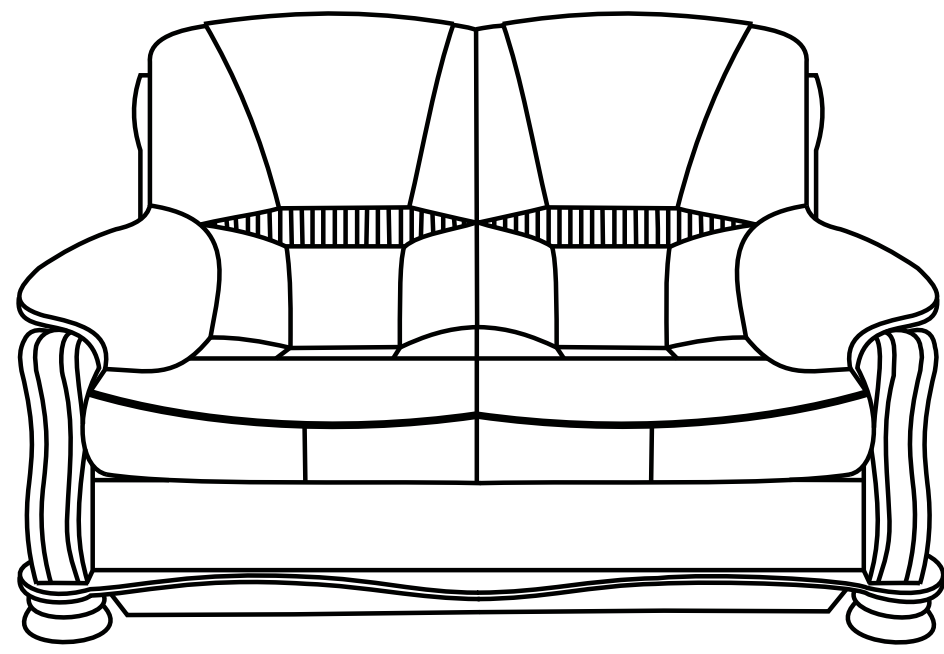

133 cm

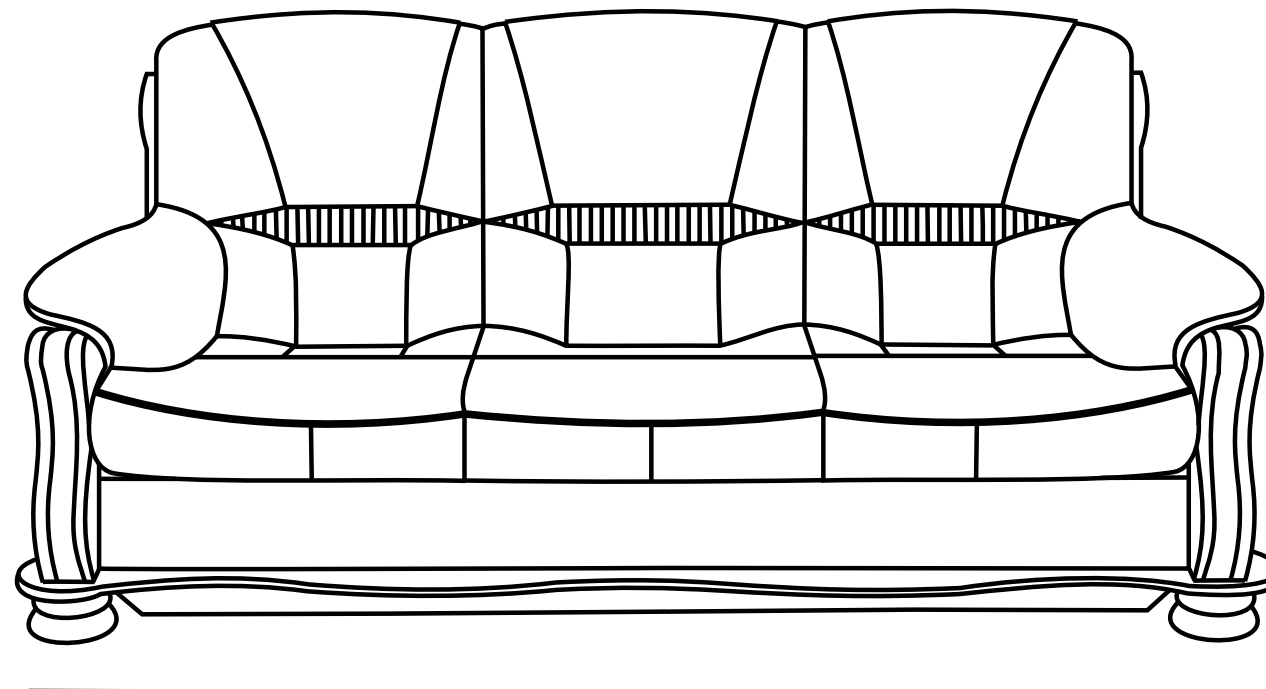

187 cm

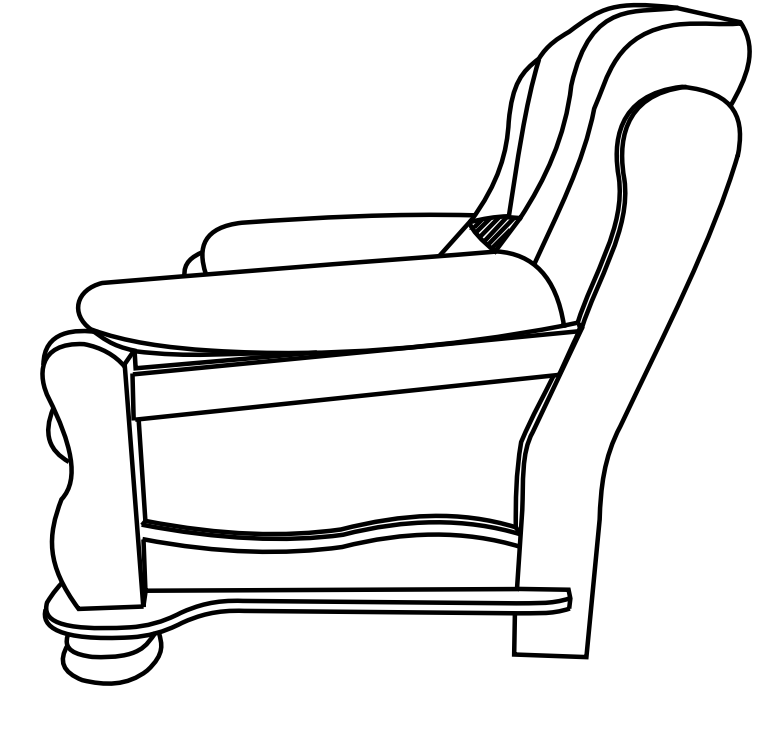

94 cm

97 cm

Pufa mała

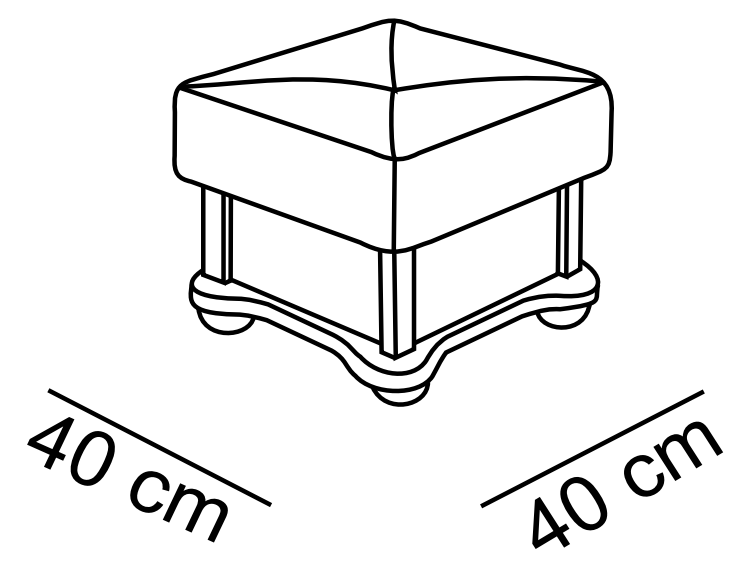

40 cm

40 cm

40 cm

Pufa duża

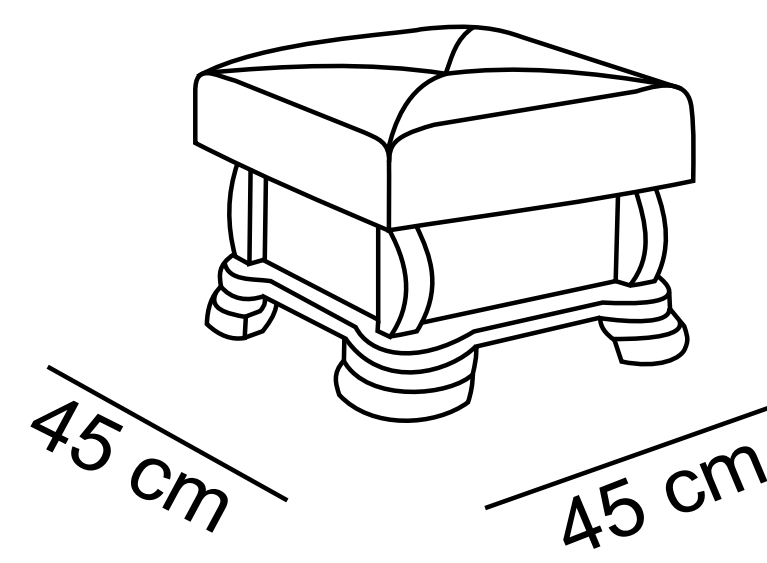

40 cm

45 cm

45 cm

[1]

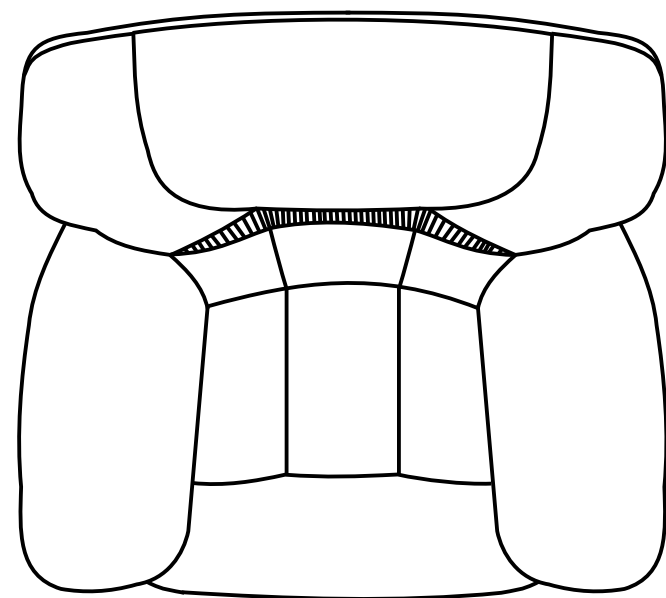

87 cm

[2]

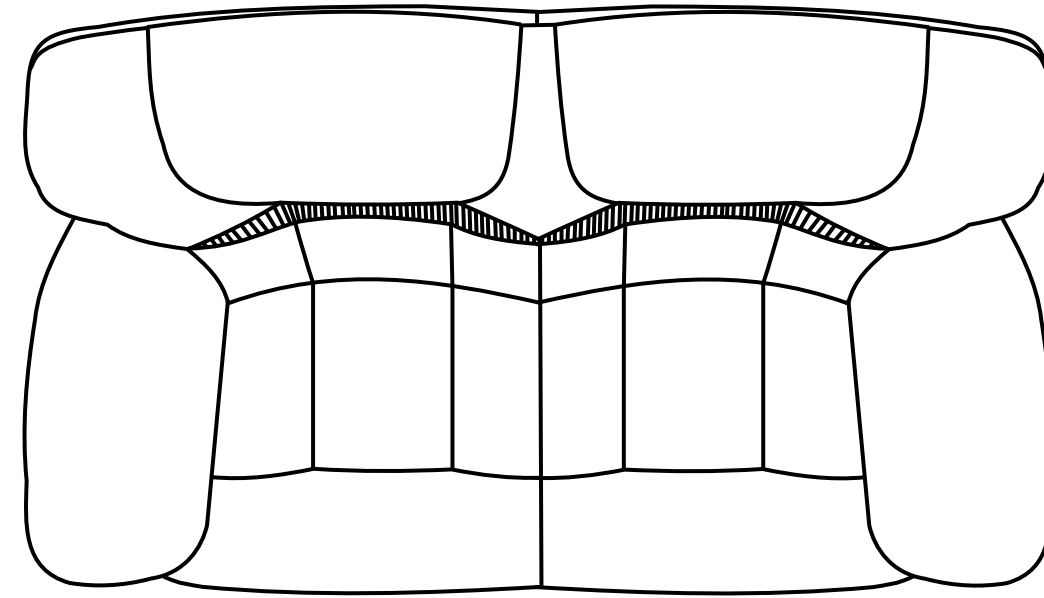

133 cm

[3]

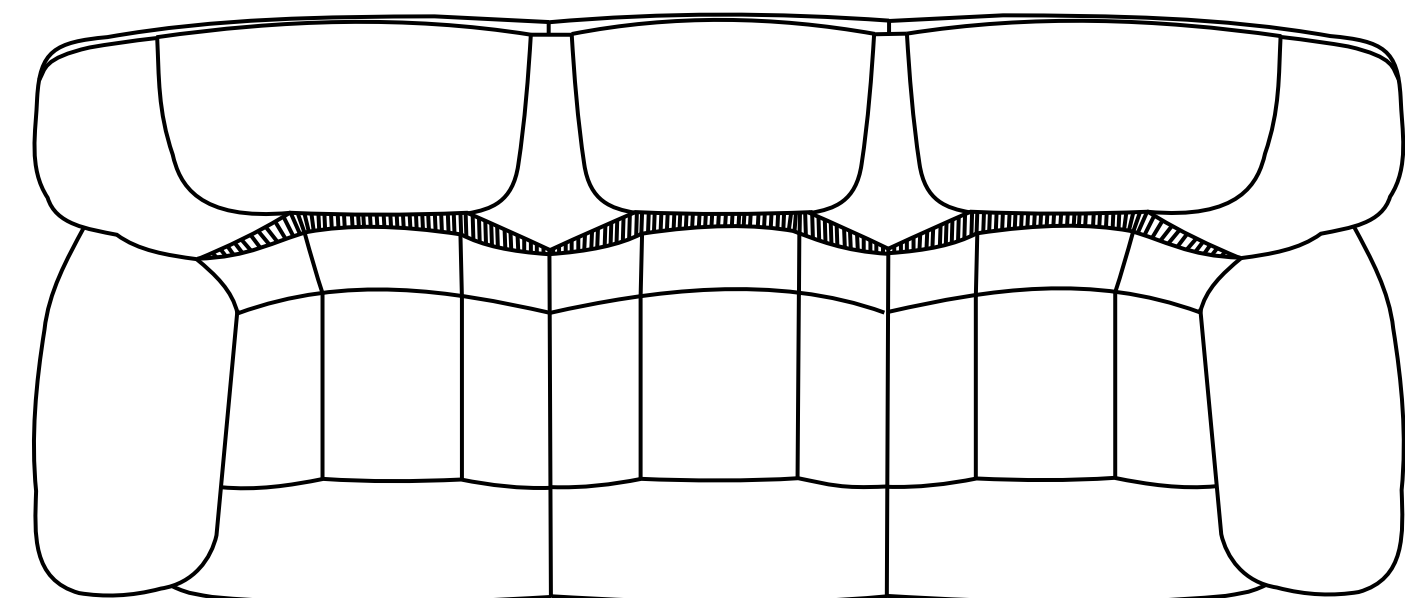

187 cm

[2F]

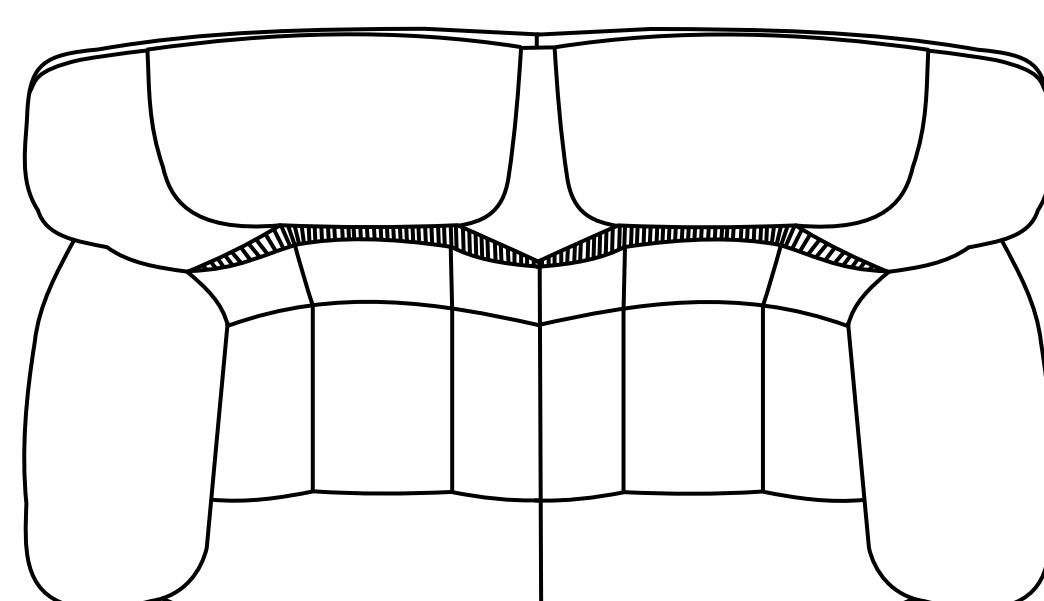

90 cm x 190 cm

[3F]

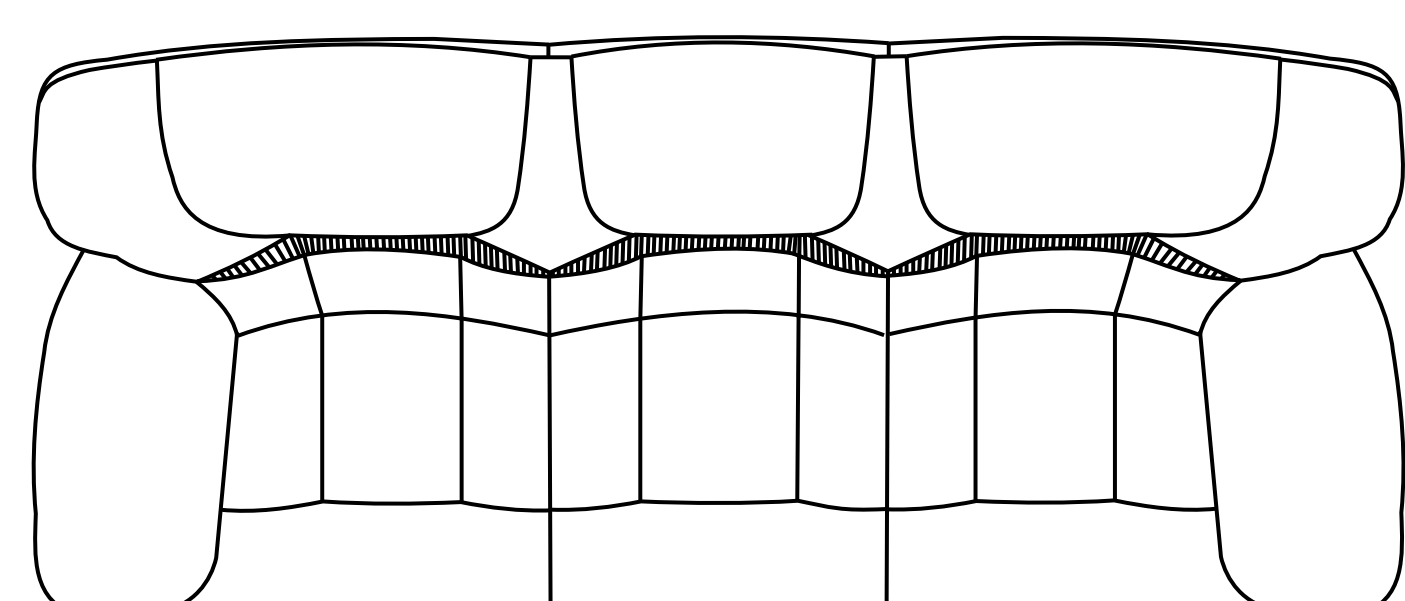

140 cm x 190 cm

- boki i tyły stelaża obite skórą naturalną za dopłatą
- możliwość zamiany funkcji spania na pojemnik
- różnica rozmiarów wykonywanych mebli w stosunku do prezentowanych w katalogu +/- 4 cm

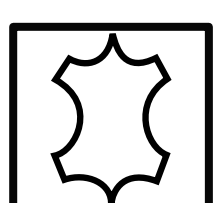

Skóra

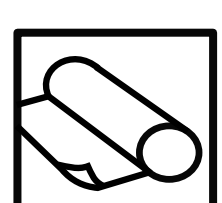

Tkanina

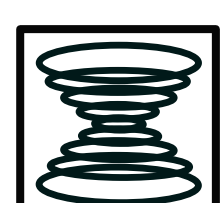

Sprężyny bonell

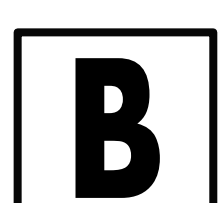

Funkcja spania belgijka

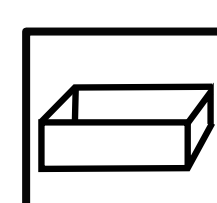

Pojemnik

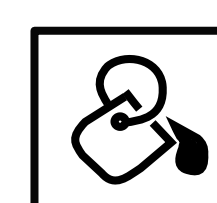

Kolor drewna

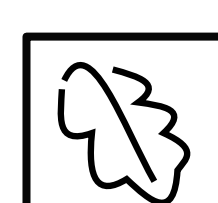

Stelaż drewniany